

# **User Manual**

## **(Digital Headset Amplifier)**

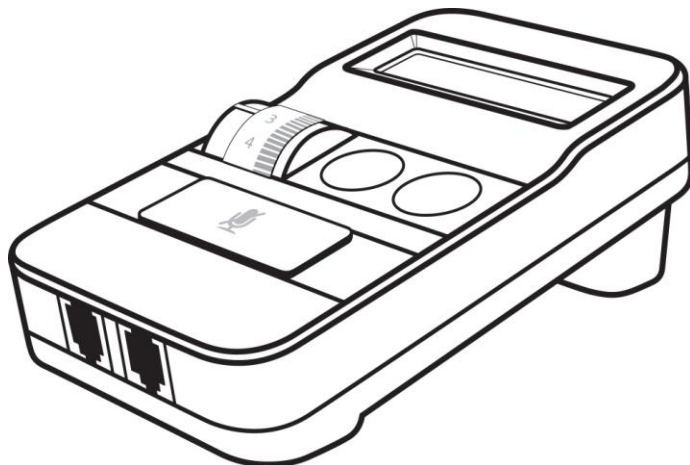

---

**ClearTalk Pro Audio**

**Processor P14875**



# 1. PRODUCT overview

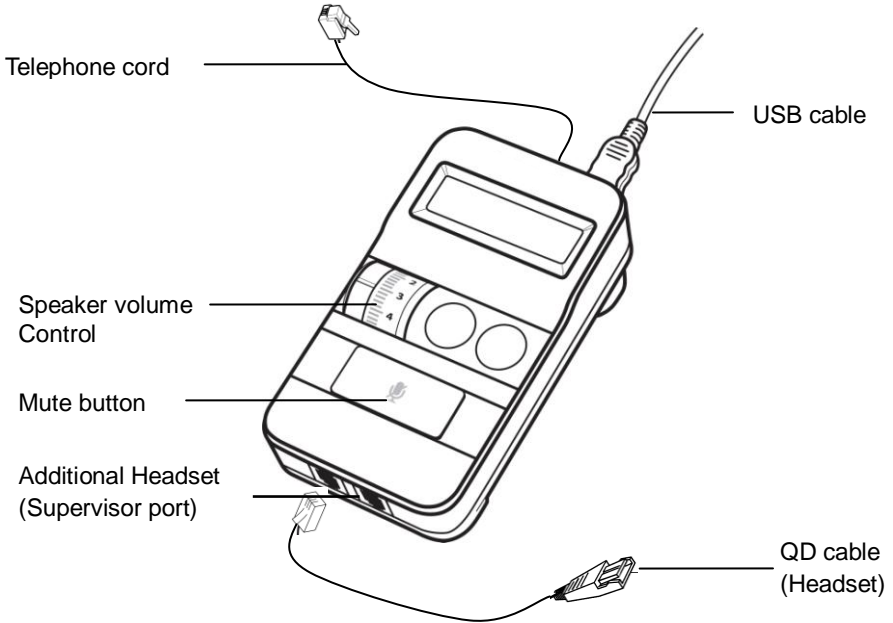

Headset/ Handset Selection Switch

Telephone Compatibility Switch

Microphone Volume

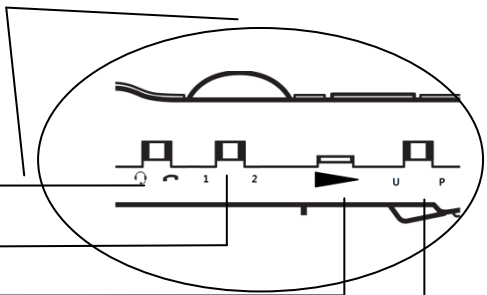

Headset Compatibility Switch

U : Universal P: Plantronics

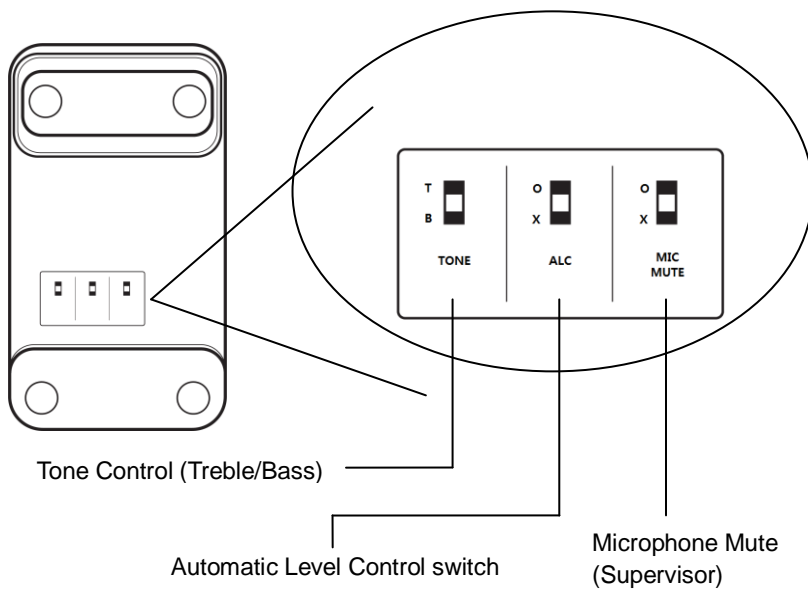

## 2. CONNECT TO POWER

Connection to a PC is necessary to power ClearTalk Pro, Plug the USB cable into the mini USB port on ClearTalk Pro, and connect the other end of the USB cable into the USB port on the PC. The 'PC/TEL' and mute indicator will be blinking twice.

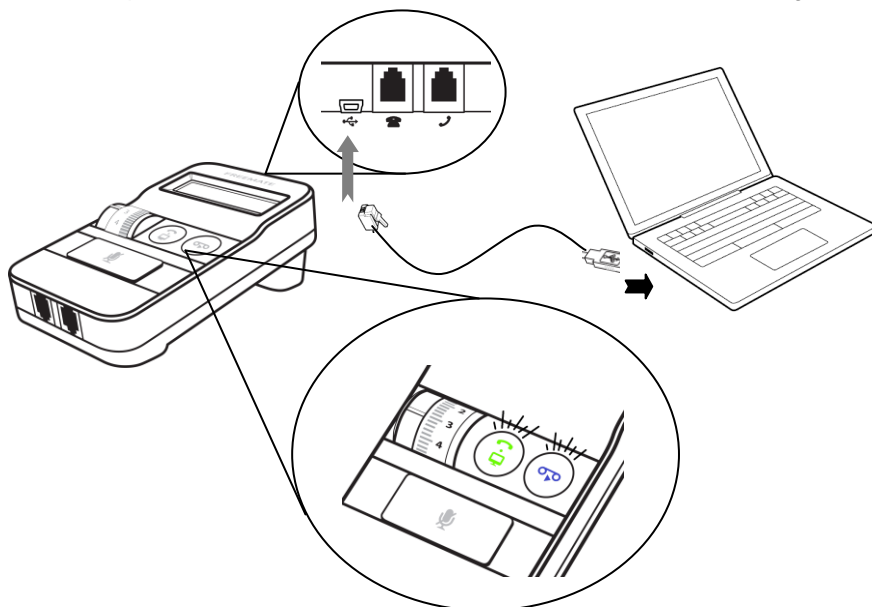

#### 4. CONNECT TO A DESK PHONE

Make sure that the telephone cord is plugged into the telephone port on the ClearTalk Pro, and then connect the other end of the telephone cord into the headset port on the desk phone.

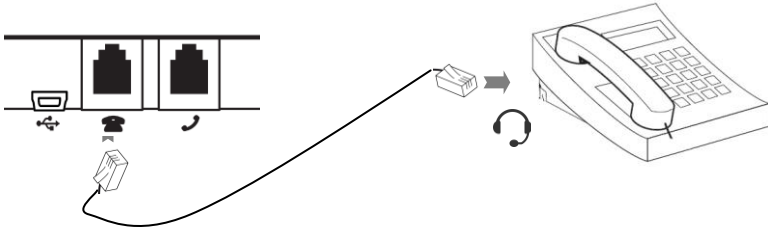

#### 5. OPERATING GIUDE

5.1 Switch headset/handset selection switch to "Headset".

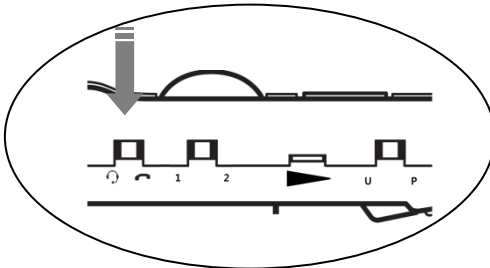

5.2 Adjust the telephone compatibility switch to '1' or '2'. The dial tone should be heard on the headset.

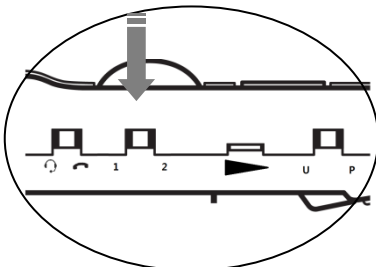

5.3 Make a test call to a colleague to test your speaking volume.

5.4 Adjust the microphone volume control on the ClearTalk Pro.

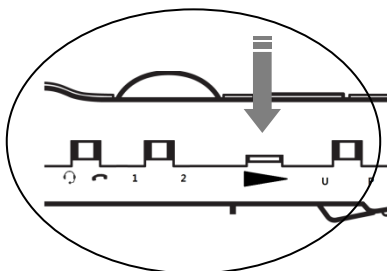

5.5 Adjust the speaker volume on the ClearTalk Pro to adjust the speaker volume

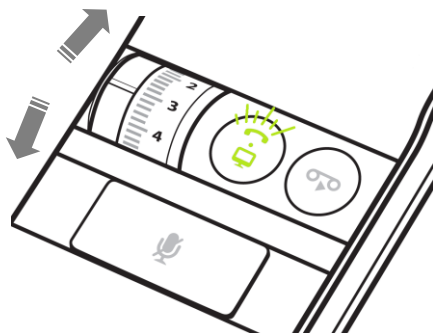

5.6 Press the mute button to mute headset microphone. The mute indicator will be ON. To Un-mute the headset microphone, press the mute button again. Indicator will be OFF.

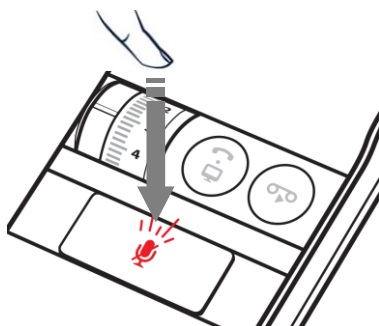

## 5.6 Connect an additional Headset

An additional headset can be connected to the supervisor port on the unit. It has the same function as the default headset. Microphone mute switch for supervisor is located on the bottom.

